



- Popis:** tvarovky odolné proti nepřímému UV záření; odolné proti vlivu kompresorových olejů (minerální oleje, oleje na bázi PAO nebo esteru); odolné vůči korozi
- Aplikace:** určeno pro potrubní rozvody různých dimenzí v průmyslových aplikacích; stlačený vzduch a dusík
- Normy:** EN 13480 / směrnice 97/23/ES a ASME B31.1 v souladu s osvědčeními pro běžné tlaky souvisejícími se schváleními PED – CE – ASME - TUV
- Pracovní tlak:** PN 13 bar (rozměry 20 - 50 mm PN 16 bar)
- Maximální podtlak:** 0,013 bar (abs) - pouze rozměry 20 - 80 mm
- Pracovní teplota:** -20/+70 °C
- Materiál:** **polymerové tvarovky** (Ø20 - 50 mm) - PA6 + 15% sklolaminát; svěrný kroužek - nerezová ocel; těsnění - pryž NBR 70° Sh
hliníkové tvarovky (Ø63 - 80 mm) - hliníková slitina EN-AB46100; svěrný kroužek - nerezová ocel; těsnění - pryž NBR 70° Sh
tvarovky z oceli-hliníku (Ø100 - 158 mm) - ocel S355MC dle normy EN10149-2; spojka - odlévaný hliník AlSi9Mg; svěrný kroužek nerezová ocel AISI 304; těsnění - pryž NBR 70°Sh



Přímé spojky APUC

Obj. č.	D1 (mm)	L (mm)	W (mm)	H (mm)	S (mm)	B (mm)	Hmotnost (kg)	Balení (ks)
APUC-20	20	127,6	37,5	-	39	50	0,07	1
APUC-25	25	138,1	43,5	-	44	50	0,1	1
APUC-40	40	208,8	67,8	-	63	80	0,35	1
APUC-50	50	239	83,9	-	78	80	0,63	1
APUC-63	63	160	89	-	-	-	0,85	1
APUC-80	80	198	113	-	-	-	1,85	1
APUC-100	100	137	138	180	67	-	2,27	1
APUC-158	158	115	192,8	227,5	55	-	3,43	1

DN 20 - 50

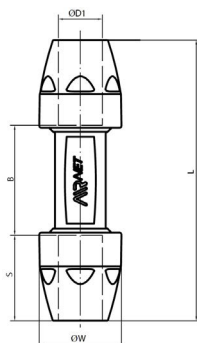

DN 63 - 80

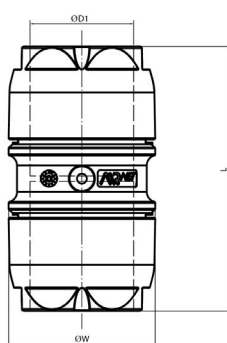

DN 100

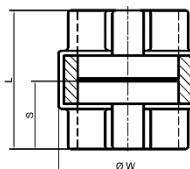
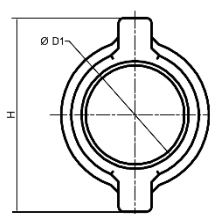

DN 158

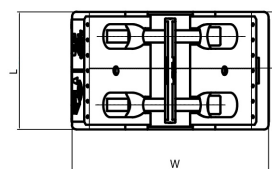
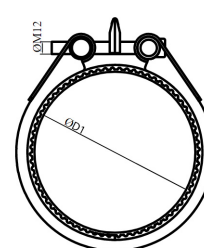



Redukované přímé spojky APG

	Obj. č.	D2 (mm)	D1 (mm)	L (mm)	W (mm)	S1 (mm)	S2 (mm)	Hmotnost (kg)	Balení (ks)
1.	APG-2025	20	25	132,8	43,5	44	38,8	0,08	1
2.	APG-2540	25	40	173,4	67,8	63	44	0,20	1
3.	APG-4050	40	50	223,9	74	78	63	0,47	1
4.	APG-5063	50	63	185	89	78	79	0,91	1
5.	APG-6380	63	80	191	113	97	78	1,66	1
6.	APG-80100	80	100	304	-	-	-	1,34	1
7.	APG-100158	100	158	269	-	-	-	2,03	1

1 - 3

4 - 5

6 - 7

1 - 3

4 - 5

6 - 7

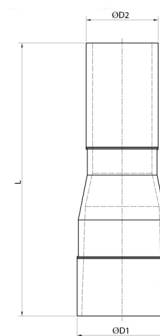
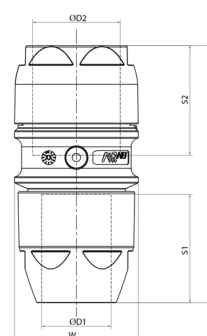
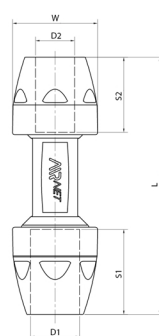

Kolena APUL 90°

Obj. č.	D1 (mm)	L (mm)	L1 (mm)	W (mm)	Hmotnost (kg)	Balení (ks)
APUL-20	20	82,5	25	37,5	0,07	1
APUL-25	25	95,7	30	43,5	0,1	1
APUL-40	40	148,3	50	67,8	0,36	1
APUL-50	50	186,1	65	83,9	0,70	1
APUL-63	63	157,5	-	89	1,02	1
APUL-80	80	196	-	113	2,31	1
APUL-100	100	252	202	-	1,23	1
APUL-158	158	248,25	170	-	2,51	1

DN 20 - 50

DN 63 - 80

DN 100 - 158

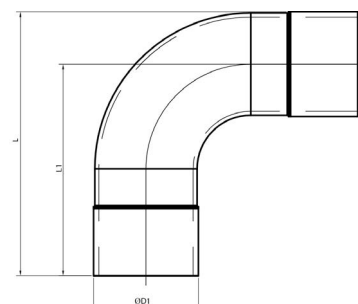
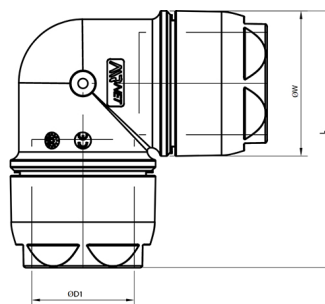
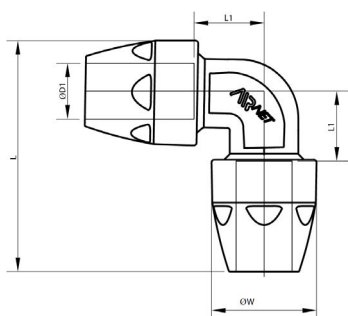



Kolena APUL 45°

Obj. č.	D1 (mm)	L (mm)	W (mm)	V (mm)	Hmotnost (kg)	Balení (ks)
APUL45-20	20	109,1	37,5	20	0,07	1
APUL45-25	25	127,9	43,5	25	0,09	1
APUL45-40	40	194,6	67,8	40	0,35	1
APUL45-50	50	240,8	83,9	50	0,66	1
APUL45-63	63	201,9	89	-	1,10	1
APUL45-80	80	246,1	112,5	-	2,30	1
APUL45-100	100	287	-	147,5	1,27	1
APUL45-158	158	285	-	134,5	2,23	1

DN 20 - 50

DN 63 - 80

DN 100 - 158

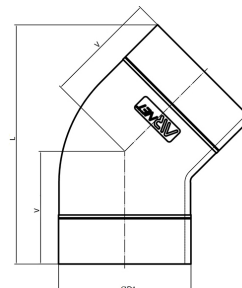
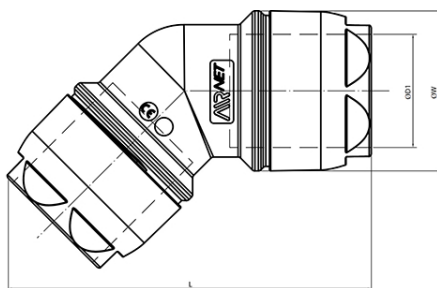
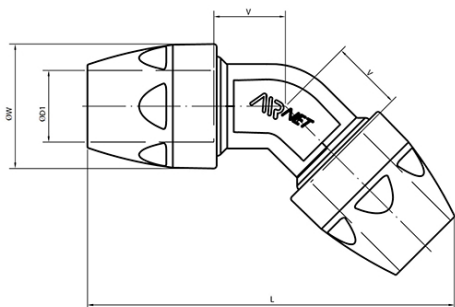

T-spojky APUT

Obj. č.	D1 (mm)	L (mm)	H (mm)	W (mm)	S (mm)	T (mm)	Hmotnost (kg)	Balení (ks)
APUT-20	20	127,6	82,6	37,5	39	25	0,10	1
APUT-25	25	147,9	95,7	43,5	44	30	0,14	1
APUT-40	40	228,8	148,3	67,8	63	50	0,53	1
APUT-50	50	289	186,1	83,9	78	65	1,02	1
APUT-63	63	226	157,1	89	78,6	-	1,42	1
APUT-80	80	280,7	196,8	113	96,5	-	3,22	1
APUT-100	100	304	202	-	-	152	1,42	1
APUT-158	158	320	238,8	-	-	160	3,54	1

DN 20 - 50

DN 63 - 80

DN 100 - 158

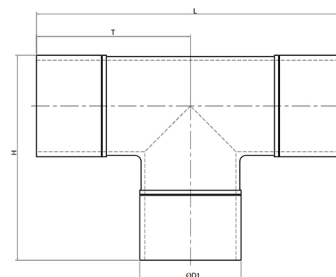
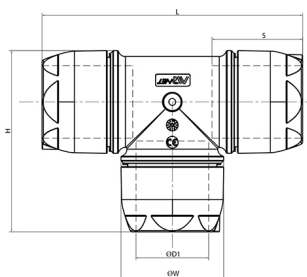
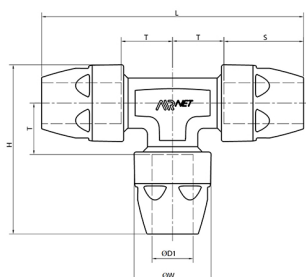



Redukované T-spojky APTG

	Obj. č.	D2 (mm)	D1 (mm)	L (mm)	H (mm)	W (mm)	W2 (mm)	T1 (mm)	T2 (mm)	Hmotnost (kg)	Balení (ks)
1.	APTG-2025	20	25	148	90,5	67,8	43,5	30	30	0,13	1
2.	APTG-2040	20	40	228,8	112,7	67,8	37,5	50	40	0,40	1
3.	APTG-2540	25	40	228,8	117,9	67,8	43,5	50	40	0,41	1
4.	APTG-2050	20	50	289	130,6	83,9	37,5	65	50	0,73	1
5.	APTG-2550	25	50	289	135,9	83,9	43,5	65	50	0,74	1
6.	APTG-4050	40	50	289	151,3	83,9	67,8	65	45	0,84	1
7.	APTG-5063	50	63	226	233	89	89	-	-	1,61	1
8.	APTG-6380	63	80	281	191	113	-	-	-	3,15	1
9.	APTG-50100	50	100	304	227	-	-	152	177	1,25	1
10.	APTG-63100	63	100	304	227	-	-	152	177	1,25	1
11.	APTG-80100	80	100	304	252	-	-	152	202	1,42	1
12.	APTG-80158	80	158	320	310,3	-	-	160	231,5	3,29	1
13.	APTG-100158	100	158	320	280,8	-	-	160	202	3,33	1

1 - 6

7 - 8

9 - 13

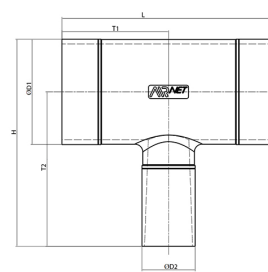
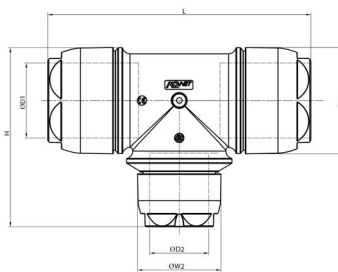
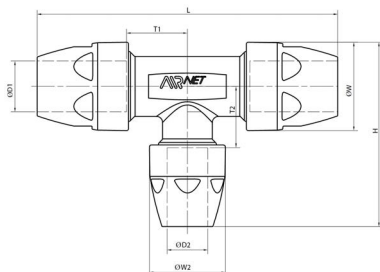



T-spojky APTF s vnitřním závitem

Obj. č.	Závít	D1 (mm)	L (mm)	Th (mm)	H (mm)	W (mm)	T (mm)	Hmotnost (kg)	Balení (ks)
APTF-3820	G 3/8"	20	127,6	28	86,4	37,5	25	0,14	1
APTF-1220	G 1/2"	20	127,6	28	86,4	37,5	25	0,13	1
APTF-1225	G 1/2"	25	148	28	94,8	43,5	30	0,19	1
APTF-3425	G 3/4"	25	148	28	94,8	43,5	30	0,17	1
APTF-1040	G 1"	40	228,8	30	138,9	67,8	50	0,60	1
APTF-1050	G 1"	50	289	30	142	83,9	65	0,91	1
APTF-2063	G 2"	63	226	32	116	89	-	1,14	1
APTF-2580	G 2 1/2"	80	281	30,2	192	113	-	2,78	1
APTF-3080	G3"	80	281	35	140	113	-	2,60	1
APTF-10100	G 1"	100	304	35	150,5	-	152	1,17	1
APTF-10158	G 1"	158	320	35	206,3	-	160	2,77	1

DN 20 - 50

DN 63 - 80

DN 100 - 158

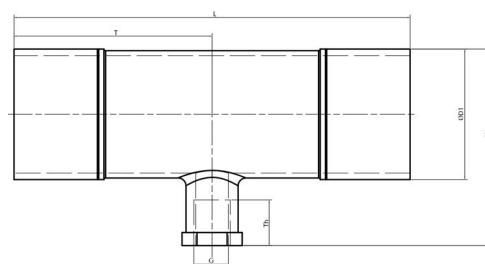
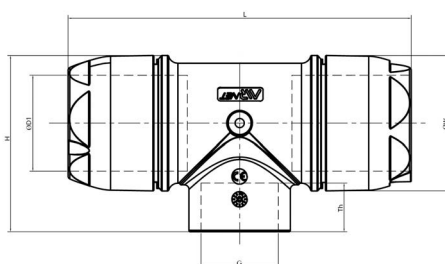
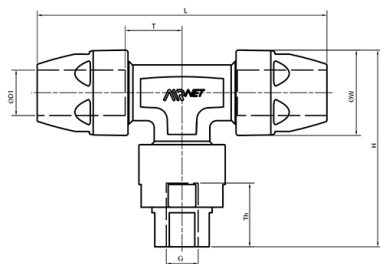

Odbočky AQD se spojkou

Obj. č.	D2 (mm)	D1 (mm)	L (mm)	H (mm)	W1 (mm)	W (mm)	N (mm)	T (mm)	C (mm)	Hmotnost (kg)	Balení (ks)
AQD-2025	20	25	103	64	37,5	37,5	15	35	26,5	0,10	1
AQD-2040	20	40	119	78	37,5	34	25	45	31	0,13	1
AQD-2540	25	40	125	83	43,5	39	25	45	32,5	0,15	1
AQD-2050	20	50	131	89	37,5	34	25	50	37	0,14	1
AQD-2550	25	50	136	94	43,5	39	25	50	39	0,16	1
AQD-2063	20	63	143	104	37,5	34	25	57	43,5	0,17	1
AQD-2563	25	63	148	110	43,5	39	25	57	46	0,19	1
AQD-2080	20	80	163	121	37,5	34	25	67	52	0,19	1
AQD-2580	25	80	168	127	43,5	39	25	67	54,5	0,21	1

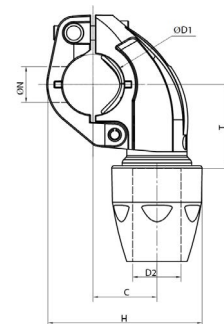
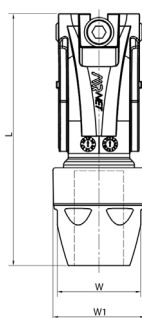

Odbočky AQF s vnitřním závitem

Obj. č.	Závět	D1 (mm)	Th (mm)	L (mm)	H (mm)	W1 (mm)	W (mm)	N (mm)	Hmotnost (kg)	Balení (ks)
AQF-1225	G 1/2"	25	25	107	65	38	36	15	0,12	1
AQF-1240	G 1/2"	40	25	124	79	48	36	25	0,15	1
AQF-3440	G 3/4"	40	25	124	83	44	41	25	0,50	1
AQF-1250	G 1/2"	50	25	135	90	38	36	25	0,17	1
AQF-3450	G 3/4"	50	25	135	95	44	41	25	0,19	1
AQF-1263	G 1/2"	63	25	148	105	38	36	25	0,19	1
AQF-3463	G 3/4"	63	25	148	110	44	41	25	0,21	1
AQF-1280	G 1/2"	80	25	167	122	38	36	25	0,22	1
AQF-3480	G 3/4"	80	25	167	127	44	41	25	0,24	1
AQF-10100	G 1"	100	20	156	168	94	63	-	2,00	1
AQF-10158	G 1"	158	20	300	200	112	63	-	2,50	1

DN 25 - 80

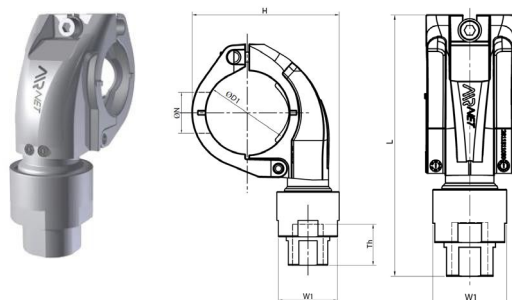

DN 100 - 158

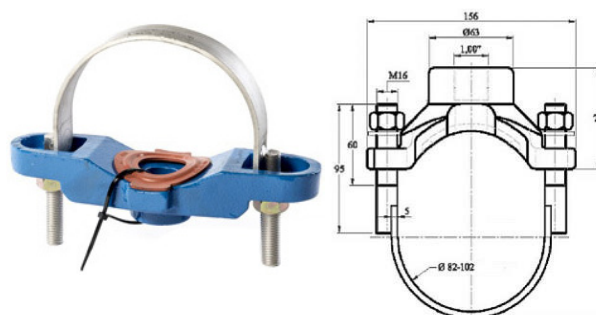



Přímé spojky APCA s vnějším závitem

Obj. č.	Závít	D1 (mm)	Th (mm)	L (mm)	W (mm)	N (mm)	S (mm)	Hmotnost (kg)	Balení (ks)
APCA-1220	R 1/2"	20	14,5	73,8	37,5	34	38,8	0,06	1
APCA-3420	R 3/4"	20	16,3	73,8	37,5	34	38,8	0,06	1
APCA-3425	R 3/4"	25	15,8	86	43,5	39	44	0,09	1
APCA-1025	R 1"	25	19,1	86	43,5	39	44	0,09	1
APCA-5440	R 1 1/4"	40	21,4	127,4	67,8	45	63	0,32	1
APCA-1540	R 1 1/2"	40	21,4	127,4	67,8	45	63	0,27	1
APCA-1550	R 1 1/2"	50	25,7	141	83,9	55	78	0,47	1
APCA-2050	R 2"	50	25,7	141	83,9	55	78	0,46	1
APCA-2063	R 2"	63	26	123	89	82	-	0,69	1
APCA-2563	R 2 1/2"	63	30	127	89	82	-	0,62	1
APCA-2580	R 2 1/2"	80	30	131	113	97	-	1,02	1
APCA-3080	R 3"	80	30	134	113	97	-	1,05	1

DN 20 - 50

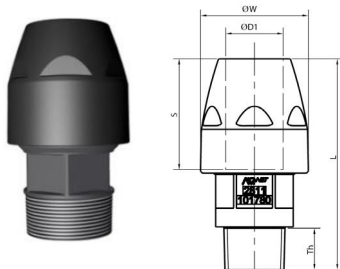

DN 63 - 80



Záslepky APP

Obj. č.	D1 (mm)	L (mm)	W (mm)	S (mm)	Hmotnost (kg)	Balení (ks)
APP-20	20	58,8	37,5	39	0,03	1
APP-25	25	69	43,5	44	0,05	1
APP-40	40	99,4	67,8	63	0,17	1
APP-50	50	119,5	83,9	78	0,32	1
APP-63	63	104	96	-	1,31	1
APP-80	80	109	115	-	1,68	1
APP-100	100	270	158	55	2,20	1

DN 20 - 50

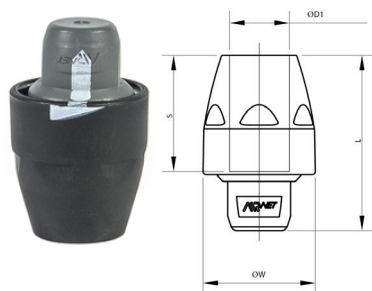

DN 63 - 80

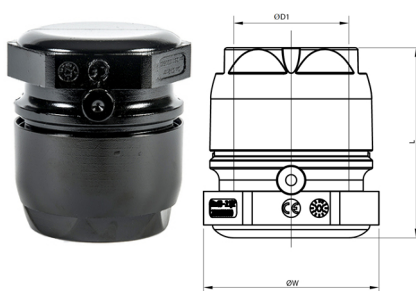

DN 100

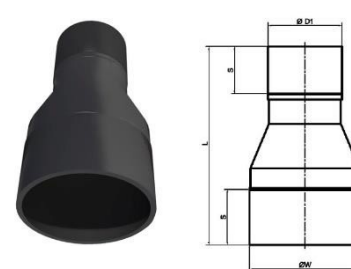

Rozebíratelné spojky ASH s vnitřním závitem

	Obj. č.	Závít	D1 (mm)	Th (mm)	L (mm)	W (mm)	N (mm)	Hmotnost (kg)	Balení (ks)
1.	ASH-3420	G 3/4"	20	25	131,8	44	41	0,11	1
2.	ASH-1025	G 1"	25	30	164,1	68,5	60	0,27	1
3.	ASH-1540	G 1 1/2"	40	40	219,4	67,8	75	0,60	1
4.	ASH-2050	G 2"	50	35	234,6	83,9	75	0,69	1
5.	ASH-2563	G 2 1/2"	63	27	182	89	113	2,41	1
6.	ASH-3080	G 3"	80	34	196	113	126	3,64	1



1 - 4

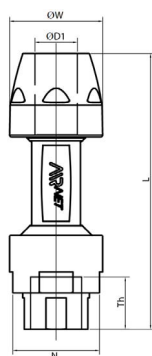

5 - 6

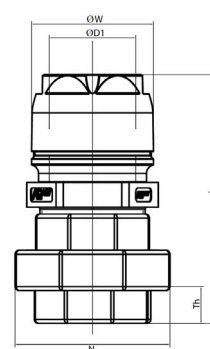

Spojovací adaptéry ASA

Obj. č.	Závít	D1 (mm)	Th (mm)	L1 (mm)	L2 (mm)	N1 (mm)	N2 (mm)	Hmotnost (kg)	Balení (ks)
ASA-3820	G 3/8"	20	25	45	17	36	24	0,06	1
ASA-1220	G 1/2"	20	25	45	17	36	24	0,05	1
ASA-1225	G 1/2"	25	25	45	17	41	30	0,07	1
ASA-3425	G 3/4"	25	25	45	17	41	30	0,06	1
ASA-1040	G 1"	40	35	58	23,5	61	40	0,18	1
ASA-1550	G 1 1/2"	50	45,5	80	35	75	60	0,33	1
ASA-2050	G 2"	50	45,5	80	35	75	60	0,36	1

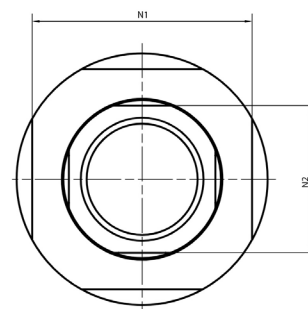
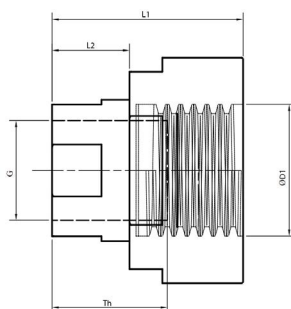

Koncové krabice AKK se spojkou

Obj. č.	Závít	D1 (mm)	H (mm)	W (mm)	Hmotnost (kg)	Balení (ks)
AKK-1220	G 1/2"	20	104,8	37,5	0,40	1
AKK-1225	G 1/2"	25	113,5	43,5	0,44	1

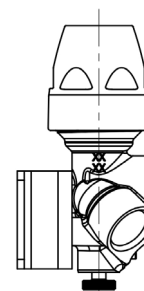
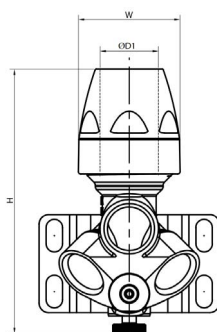



Koncové krabice AKKT se závitem na vstupu

Obj. č.	D2	D1	Th (mm)	H (mm)	Hmotnost (kg)	Balení (ks)
AKKT-1212	G 1/2"	G 1/2"	16,7	77,5	0,35	1
AKKT-1234	G 1/2"	G 3/4"	16,4	77,5	0,35	1

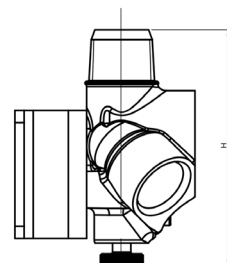
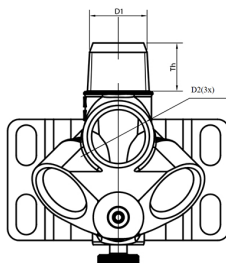

Příruby AFG

Obj. č.	D1 (mm)	D2 (mm)	L (mm)	W (mm)	Hmotnost (kg)	Balení (ks)
AFG-065	63 DIN	145	82	185	0,87	1
AFG-080	80 DIN	160	101	200	1,43	1
AFG-100	100 DIN	180	132	220	2,57	1
AFG-158	158 DIN/ANSI	240	132	285	5,34	1
AFT-065	těsnění DN65					1
AFT-080	těsnění DN80					1
AFT-100	těsnění DN100					1
AFT-158	těsnění DN150					1
AFSS-100	sada šroubů DN100					8
AFSS-158	sada šroubů DN150					8



DN 65 - 80

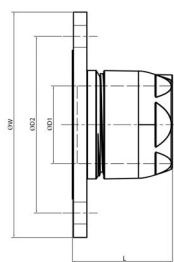

DN 100 - 158

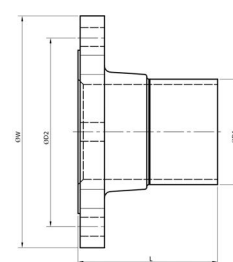

Kulové kohouty se spojkami ABV

Obj. č.	D1 (mm)	L (mm)	L1 (mm)	H (mm)	B (mm)	C (mm)	Hmotnost (kg)	Balení (ks)
ABV-20	20	131	120	73	53	35	0,55	1
ABV-25	25	150	120	83	62	35	0,79	1
ABV-40	40	236	158	156	75	70,3	1,96	1
ABV-50	50	236	158	156	77	70,3	3,09	1

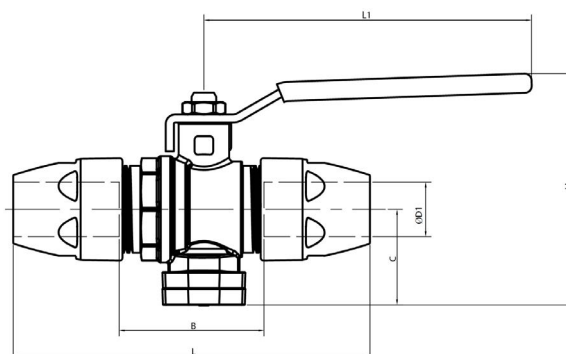

Kulové kohouty ABVF se spojkou a vnitřním závitem

Obj. č.	Závít	D1 (mm)	L (mm)	L1 (mm)	H (mm)	Th (mm)	C (mm)	Hmotnost (kg)	Balení (ks)
ABVF-3420	G 3/4"	20	92,8	120	84,7	15	35	0,52	1
ABVF-1025	G 1"	25	111,9	120	88,7	18,5	35	0,76	1
ABVF-1540	G 1 1/2"	40	204	158	148,5	20,5	70,3	1,56	1
ABVF-2050	G 2"	50	176,2	158	156	26	70,3	2,80	1

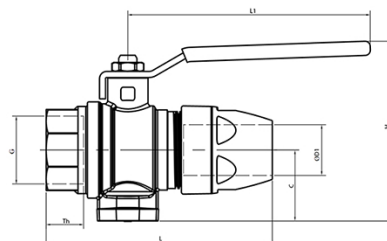

Uzavírací klapky AFV

Obj. č.	D1 (mm)	L (mm)	H (mm)	Hmotnost (kg)	Balení (ks)
AFV-63	63	216	325,5	4,28	1
AFV-80	80	247	339	5,56	1
AFV-100	100	52	380	7,90	1
AFV-158	158	62	451	8,40	1

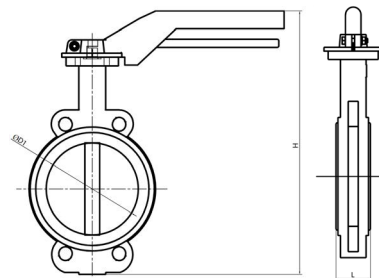

Uzavírací klapky AFVF se spojkou a vnitřním závitem

Obj. č.	D1 (mm)	Závít	L (mm)	H (mm)	Hmotnost (kg)	Balení (ks)
AFVF-2563	63	G 2 1/2"	170	325	3,88	1
AFVF-3080	80	G 3"	188	339	4,66	1

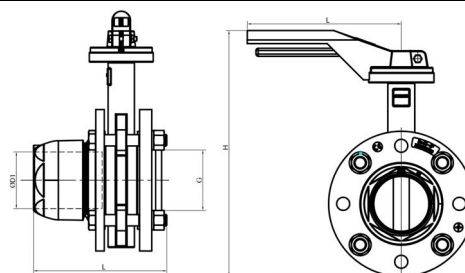

Podpěry příruby AFVS

Obj. č.	D1 (mm)	L (mm)	H (mm)	W (mm)	Hmotnost (kg)	Balení (ks)
AFVS-63	63	150	95	60	0,62	1
AFVS-80	80	160	90	60	0,62	1
AFVS-100	100	225	140	60	1,03	1
AFVS-158	158	220	145	70	1,03	1

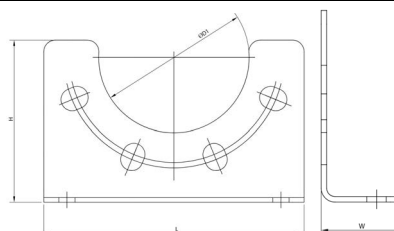



Matice spojek AMT

Obj. č.	D1 (mm)	W (mm)	S (mm)
AMT-20	20	37,5	39
AMT-25	25	43,5	44
AMT-40	40	67,5	63
AMT-50	50	83,9	78

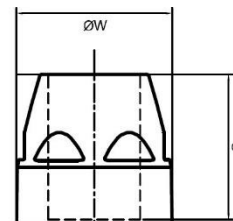
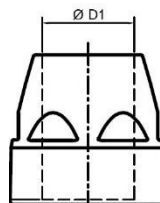

Flexibilní hadice AFH

Obj. č.	D1 (mm)	L (mm)	Provedení	Připojení	Závit	Hmotnost (kg)	Balení (ks)
AFH-2007	20	750	přímé	závit	G 3/4"	0,06	1
AFH-2015	20	1500	přímé	závit	G 3/4"	0,06	1
AFH-2507	25	750	přímé	závit	G 1"	0,43	1
AFH-2515	25	1500	přímé	závit	G 1"	0,81	1
AFH-4010	40	1000	90°	závit	G 1 1/2"	0,95	1
AFH-4015	40	1500	přímé	závit	G 1 1/2"	1,33	1
AFH-5010	50	1000	90°	závit	G 2"	1,24	1
AFH-5015	50	1500	přímé	závit	G 2"	1,69	1
AFH-6310	63	1000	90°	příruba	145	2,12	1
AFH-6315	63	1500	přímé	příruba	145	2,77	1
AFH-8010	80	1900	90°	příruba	160	2,86	1
AFH-8015	80	1500	přímé	příruba	160	3,23	1

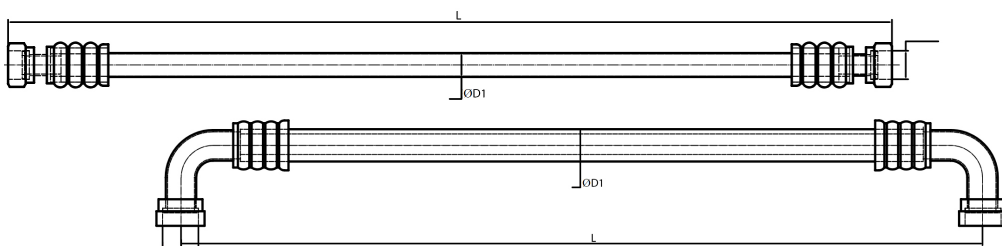

Ochranné pásy AHP

Obj. č.	Rozměr (mm)	Balení (ks)
AHP-032	20 - 32	1
AHP-080	40 - 80	1



Nosník ANN

Obj. č.	L (mm)	W (mm)	H (mm)	Tloušťka	Hmotnost (kg)	Balení (ks)
ANN-20	2000	30	27	1,5	0,27	5

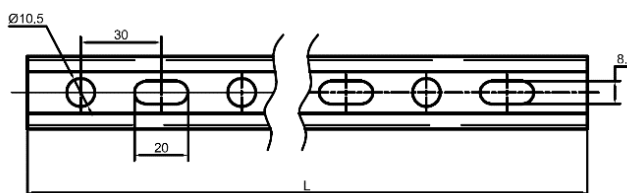
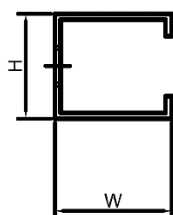



Konzola ANK

Obj. č.	L (mm)	L1 (mm)	W (mm)	W1 (mm)	H (mm)	H1 (mm)	Tloušťka (mm)	Hmotnost (kg)	Balení (ks)
ANK-50	36	50	71	5	20	114	5	0,07	5

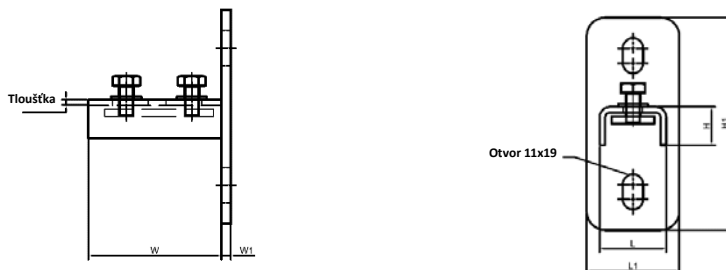

Ramena konzol ANR

Obj. č.	L (mm)	L1 (mm)	W (mm)	W1 (mm)	H (mm)	H1 (mm)	Tloušťka	Hmotnost (kg)	Balení (ks)
ANR-30	27	40	30	120	300	6	1,5	0,07	5
ANR-50	27	40	30	120	534	6	1,5	0,10	5

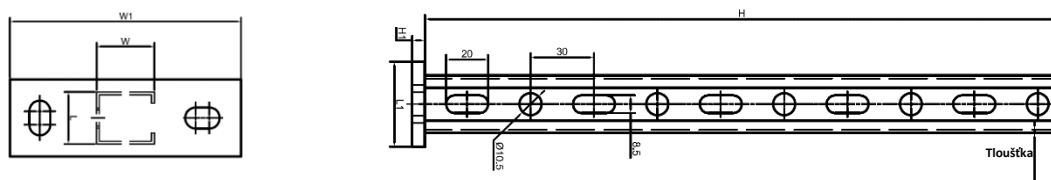

Závěsné šrouby ANT

Obj. č.	Závít	L (mm)	T (mm)	W1 (mm)	W2 (mm)	Hmotnost (kg)	Balení (ks)
ANT-30	M8	30	4	25	14	0,02	10
ANT-40	M8	40	4	25	14	0,22	10
ANT-60	M8	60	4	25	14	0,03	10
ANT-80	M8	80	4	25	14	0,04	10



Krytka nosníku ANKO

Obj. č.	D (mm)	L (mm)	T (mm)	W1 (mm)	Hmotnost (kg)	Balení (ks)
ANKO	29	18,5	5	30	0,01	10

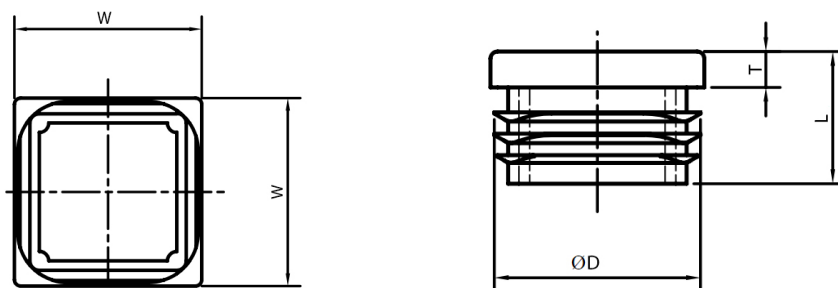

Přichytky a objímky trubek ADT

Obj. č.	D1 (mm)	L (mm)	C (mm)	B (mm)	Závit	Hmotnost (kg)	Balení (ks)
ADT-20	20	57,1	35	25	M6	0,01	20
ADT-25	25	59,1	35	25	M6	0,01	20
ADT-40	40	88,3	50	25	M6	0,03	20
ADT-50	50	94,2	50	30	M6	0,04	20
ADT-63	63	120,6	70	35	M8	0,06	20
ADT-80	80	135,1	70	45	M8	0,11	20
ADT-100	100	165	76	23	M10	0,18	10
ADT-158	158	222	102	23	M10	0,26	10

DN 20 - 80



DN 20 - 80

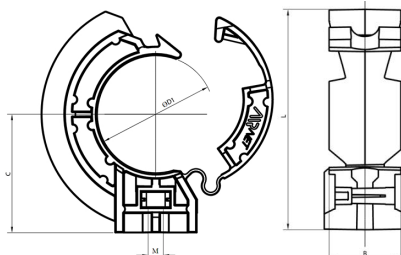

DN 100 - 158

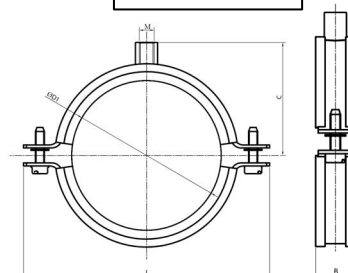

Podstavce přichytek APR

	Obj. č.	D1 (mm)	L (mm)	B (mm)	H (mm)	Hmotnost (kg)	Balení (ks)
1.	APR-25	20 - 25	15	34,8	21	0,01	10
2.	APR-50	40 - 50	20	61,1	27	0,02	10
3.	APR-80	63 - 80	30	61,4	37	0,26	10
4.	APR-100	100	40	40	49,5	0,13	10

1



3

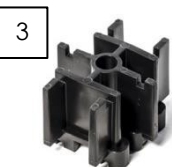

DN 25 - 80

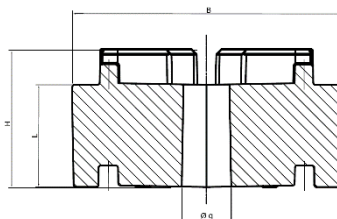

2



4



DN 100

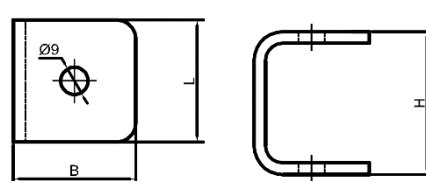

Zatlačovací svorky ASZ

Obj. č.	Závit	Rozsah (mm)	Hmotnost (kg)	Balení (ks)
ASZ-03	M8	2 - 3	0,03	10
ASZ-08	M8	3 - 8	0,03	10
ASZ-14	M8	8 - 14	0,03	10
ASZ-20	M8	14 - 20	0,03	10

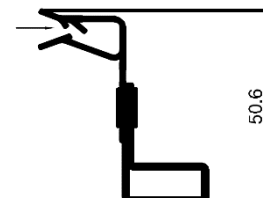
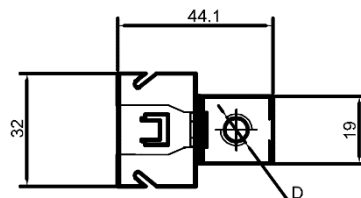



Svorky se šroubem ASS

Obj. č.	Závit	Hmotnost (kg)	Balení (ks)
ASS-18	M8	0,11	10

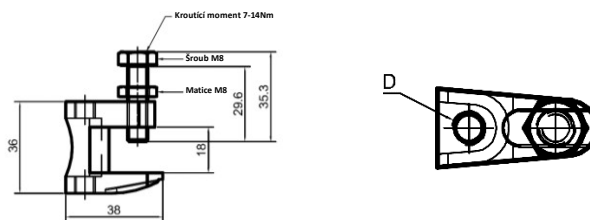

Závěsné svorky ASV

Obj. č.	Závit	Rozsah (mm)	Hmotnost (kg)	Balení (ks)
ASV-04	M8	1,5 – 4	0,02	10
ASV-07	M8	4 – 6,5	0,02	10

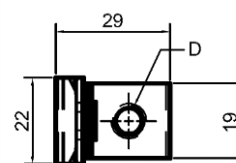
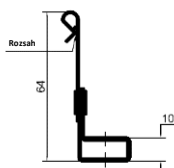

Závěs s U-šroubem AZU

Obj. č.	H (mm)	H1 (mm)	W (mm)	W1 (mm)	T (mm)	Hmotnost (kg)	Balení (ks)
AZU	76	20	60	43	4	0,17	10

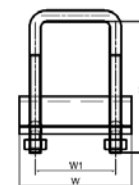
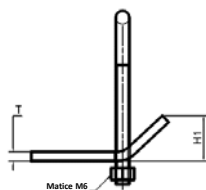

Stropní závěsy AZS

Obj. č.	Závit	Rozsah (mm)	Hmotnost (kg)	Balení (ks)
AZS	M8	0,8 - 3	0,02	10

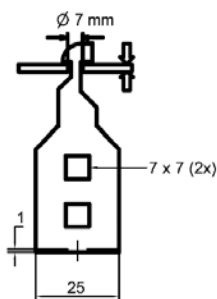



Příslušenství

	Obj. č.	Popis	Balení (k)
1.	AZP	Profilový závěs	1
2.	AVD-63	Vnitřní díl spojek (63 mm)	5
	AVD-80	Vnitřní díl spojek (80 mm)	5
3.	AQDS-25	O-kroužky pro odbočky AQD/AQF (25 mm)	10
	AQDS-50	O-kroužky pro odbočky AQD/AQF (40 - 50 mm)	10
	AQDS-80	O-kroužky pro odbočky AQD/AQF (63 - 80 mm)	10
	AOR-63	O-kroužky pro spojky (63 mm)	10
	AOR-80	O-kroužky pro spojky (80 mm)	10
	AS-100	Šrouby 100 mm	10
4.	ABOX-50	Kufr s nářadím (20 - 50 PF)	1
5.	AKF-KL20-PF	Dotahovací klíč (20 PF)	1
	AKF-KL25-PF	Dotahovací klíč (25 PF)	1
	AKF-KL40-PF	Dotahovací klíč (40 PF)	1
	AKF-KL50-PF	Dotahovací klíč (50 PF)	1
	AKF-KL63	Dotahovací klíč (63 mm)	1
	AKF-KL80	Dotahovací klíč (80 mm)	1
6.	AKF-KLL5	Imbusový klíč (5 mm)	1
	AKF-KLL	Imbusový klíč (6 mm)	1
7.	AKF-RZ	Řezák na trubky (20 - 50 mm)	1
	AKF-RZ100	Řezák na trubky (50 - 100 mm)	1
	AKF-RZ158	Řezák na trubky (100 - 158 mm)	1
	AKF-NRK	Náhradní kolečko pro AKF-RZ	1
	AKF-NRK100	Náhradní kolečko pro AKF-RZ100/158	1
8.	AKF-OTP	Odhrotovač plastový (20 - 25 mm)	1
	AKF-OT	Odhrotovač kovový (20 - 50 mm)	1
9.	AKF-OO	Škrabka na hrany trubek	1
10.	AKF-NV14	Vrtací nástavec pro odbočky (14 mm)	1
	AKF-NV19	Vrtací nástavec pro odbočky (19 mm)	1
	AKF-NV24	Vrtací nástavec pro odbočky (24 mm)	1
	AKF-DV	Držák na vrtací nástavce	1
11.	AKF-MZ	Mazivo Airnet	1
12.	AKF-PP-PF	Popisovač trubek (20 - 50 mm)	1
13.	AKF-MK	Momentový klíč	1
	AKF-HMK	Hlava momentového klíče	1

